

Cosse Y323L - Y323A

Cosses MFOM - Cosses MFOM pour CI - 6,35 x 0,8

 Acheter ce produit en ligne

www.mfom.fr

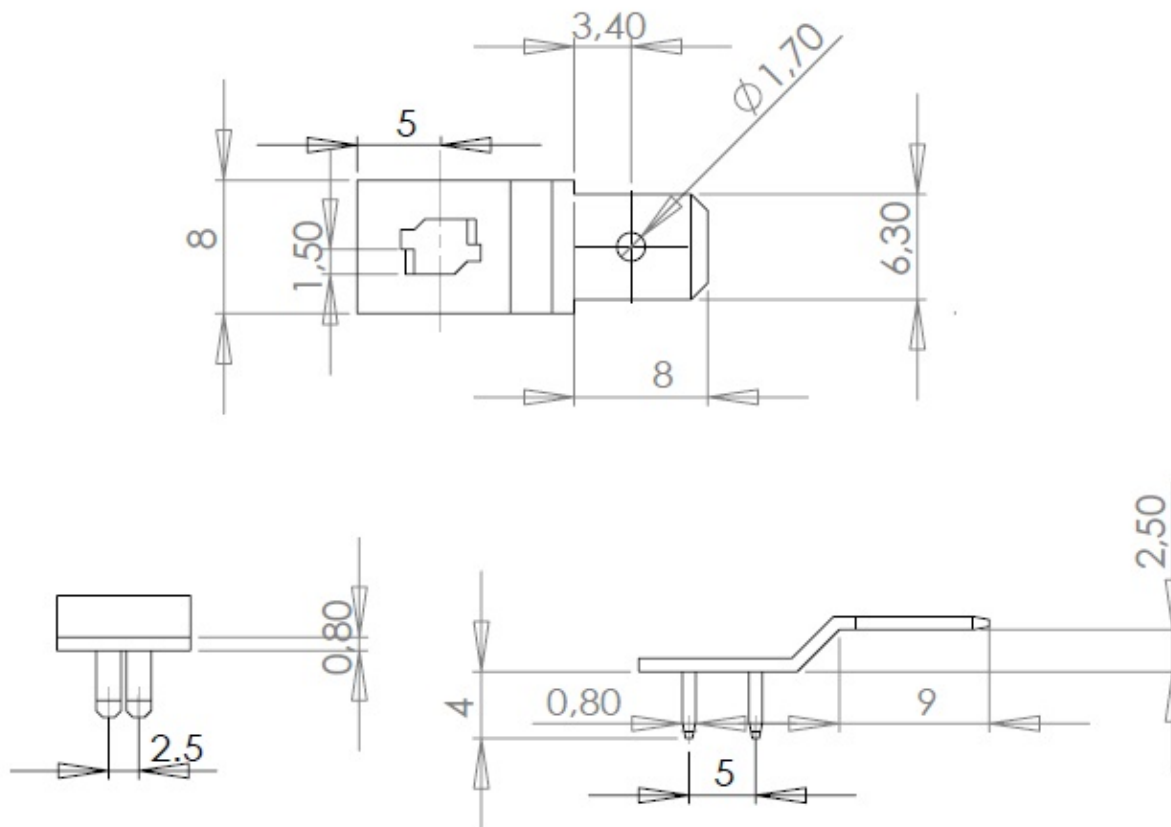
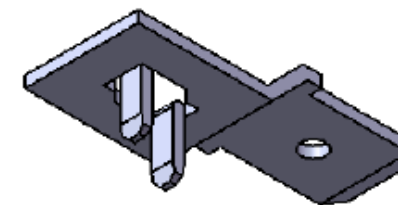

Matières

L = Laiton étamé RoHS • A = Acier étamé RoHS