

Cosse Y302L - Y302A

Cosses MFOM - Cosses MFOM pour CI - 2,8 x 0,8

 Acheter ce produit en ligne

www.mfom.fr

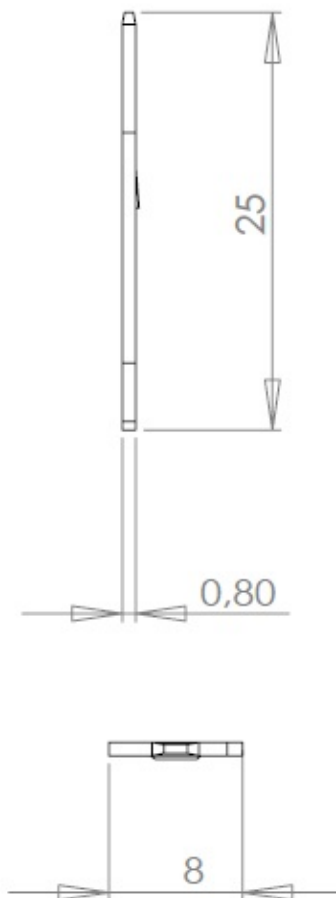
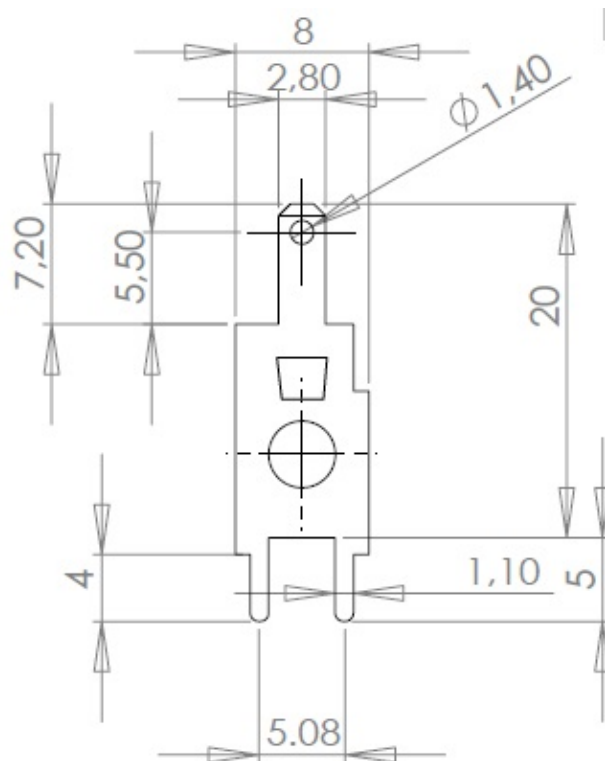

Matières

L = Laiton étamé RoHS • A = Acier étamé RoHS