

Cosse Y320L - Y320A

Cosses MFOM - Cosses MFOM pour CI - 6,35 x 0,8

 Acheter ce produit en ligne

www.mfom.fr

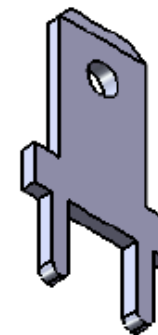
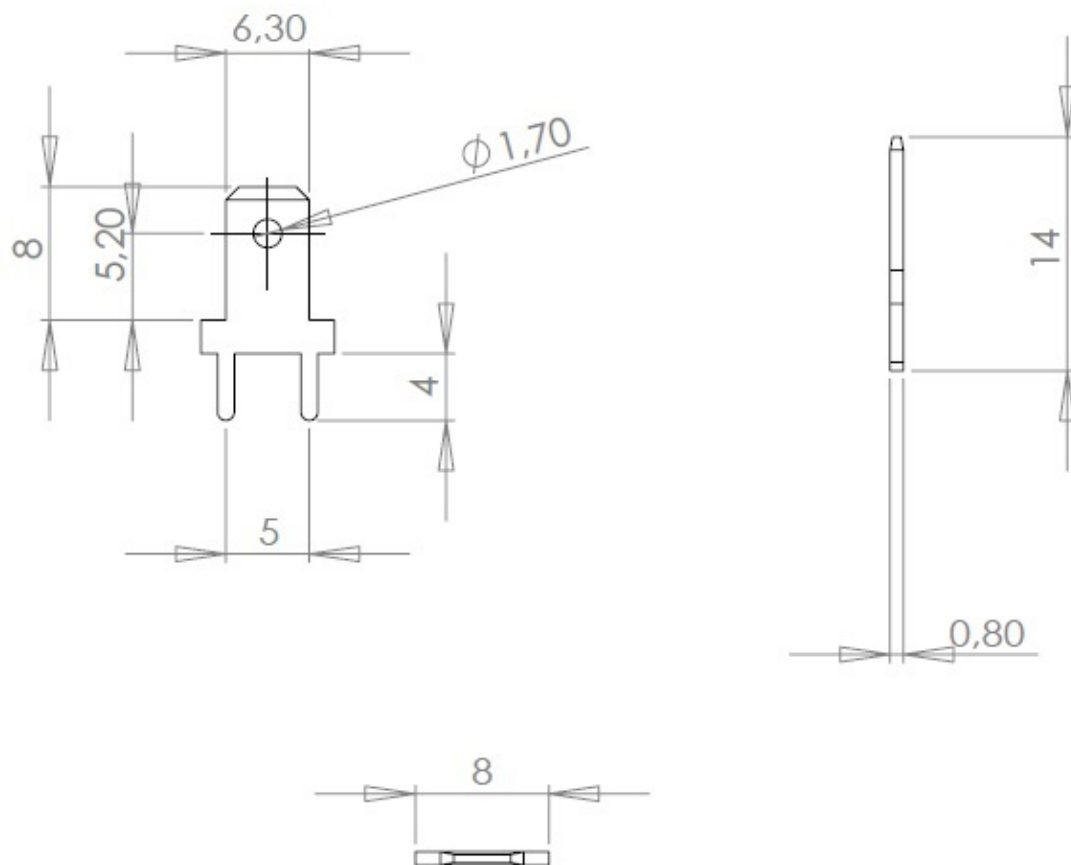

Matières

L = Laiton • A = Acier